

SPEZIALLEUCHTEN | SPECIAL LUMINAIRES

ALASCO 65 ICE



Beschreibung | description

Diese vandalismussichere LED-Einzelbatterieleuchte – mit temperaturgeführter Begleitheizung zur Erhaltung der optimalen Akkutemperatur bei niedrigen Umgebungstemperaturen – eignet sich für den Einsatz in Bereichen mit erhöhtem Sicherheitsanspruch.

The vandal-proof LED single battery luminaire – with temperature-controlled heat tracing for an optimal battery temperature preservation at low temperatures – is well suitable for areas with special security requirements.

mehr Details | more details



360°-Ansicht, Projektierungshilfen, lichttechnische Daten, Ausschreibungstexte

360 degree view, project planning helps, photometric data, tender texts

www.gaz.de

Technische Daten | specifications

Einzelbatterieleuchte single battery luminaires	
Gehäuse housing	Stahlblech verzinkt, weiß RAL 9016, Scheibe IK10 galvanized steel sheet, white RAL 9016, pane IK10
Piktogramm pictogram	Standardpiktogrammsatz liegt bei including standard pictogram
Montageart mounting possibilities	Rettungszeichenleuchte: Wandmontage (WM) Sicherheitsleuchte: Wandmontage (WM) / Deckenmontage (DM) exit sign luminaire: wall mounting (WM) emergency luminaire: wall mounting (WM) / ceiling mounting (DM)
Erkennungsweiten viewing distance	34 m
Anschlussspannung (AC/DC) supply voltage (AC/DC)	230 V / -
Anschlussleistung (AC/DC) power rating (AC/DC)	Rettungszeichenleuchte exit sign luminaire: 7 VA, Heizung heating (-25° C): 4 W Sicherheitsleuchte emergency luminaire: 12 VA, Heizung heating (-25° C): 4 W
Leuchtmittel illuminant	Rettungszeichenleuchte exit sign luminaire: LED Sicherheitsleuchte emergency luminaire: LED / 314 lm
Akku accu	NiCd- oder NiMh-Akku, Nennbetriebsdauer: 3 h / 8 h NiCd or NiMh battery, rated operating time: 3 h / 8 h
Gewicht weight	2,8 kg
Umgebungstemperatur ambient temperature	-25° C <> +40° C
Schutzart protection degree	IP65
Schutzklasse protection class	I

gem. DIN EN 60598-1, DIN EN 60598-2-22, DIN 4844-1, DIN EN ISO 7010, DIN EN 1838

SPEZIALLEUCHTEN | SPECIAL LUMINAIRES | ALASCO 65 ICE

Optionen | options

Einzelbatterieleuchte
single battery luminaire

SelfControl SC
SelfControl SC

LineControl LC
LineControl LC

DaliLineControl DLC
DaliLineControl DLC





wählbare Gehäuse | selectable housing:

 Stahlblech verzinkt, weiß RAL 9016
galvanized steel sheet, white RAL 9016

 Edelstahl V2A 1.4301 / V4A 1.4571
stainless steel V2A 1.4301 / V4A 1.4571

Projektierungshilfen | project planning helps

ALASCO 65 E WM/DM (S) 314 lm

Höhe (m) height (m)	Montageart mounting type	Abstand (m) distances (m)				
2,0	DM					
2,5	DM	3,61	8,79	8,83	8,86	3,61
3,0	DM	4,00	9,74	9,81	9,87	4,00
3,5	DM	4,28	10,53	10,62	10,70	4,28
4,0	DM	4,48	11,30	11,35	11,41	4,48
4,0	DM	4,60	11,96	11,97	11,98	4,60

Maße | dimension (mm)

Wandmontage | wall mounting

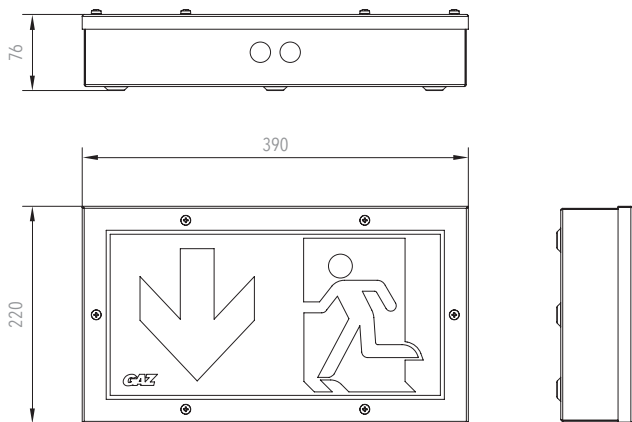

Wandhalterung | wall bracket

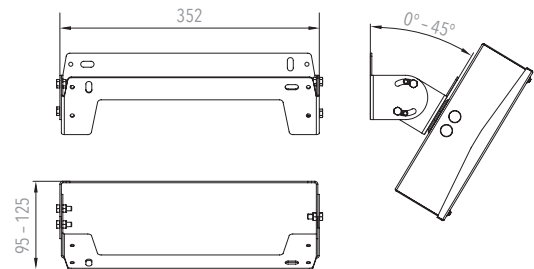

Zubehör | accessories

Bezeichnung designation	Art.-Nr. item no
Kettenbefestigungsset K002 IP65 chain attachment set K002 IP65	1219000016
Aufputzadapter 10, weiß surface-mounting adapter 10, white	1219000018
Aufputzadapter 10, Edelstahl surface-mounting adapter 10, stainless steel	1219000058
Wandhalter schwenkbar, weiß swivelling wall bracket, white	5110010305
Wandhalter schwenkbar, Edelstahl swivelling wall bracket, stainless steel	1219000057
Sonderpiktogramme special pictogram	



Ausführung als Sicherheitsleuchte
version as an emergency luminaire